

SCHEMATIC DIAGRAM

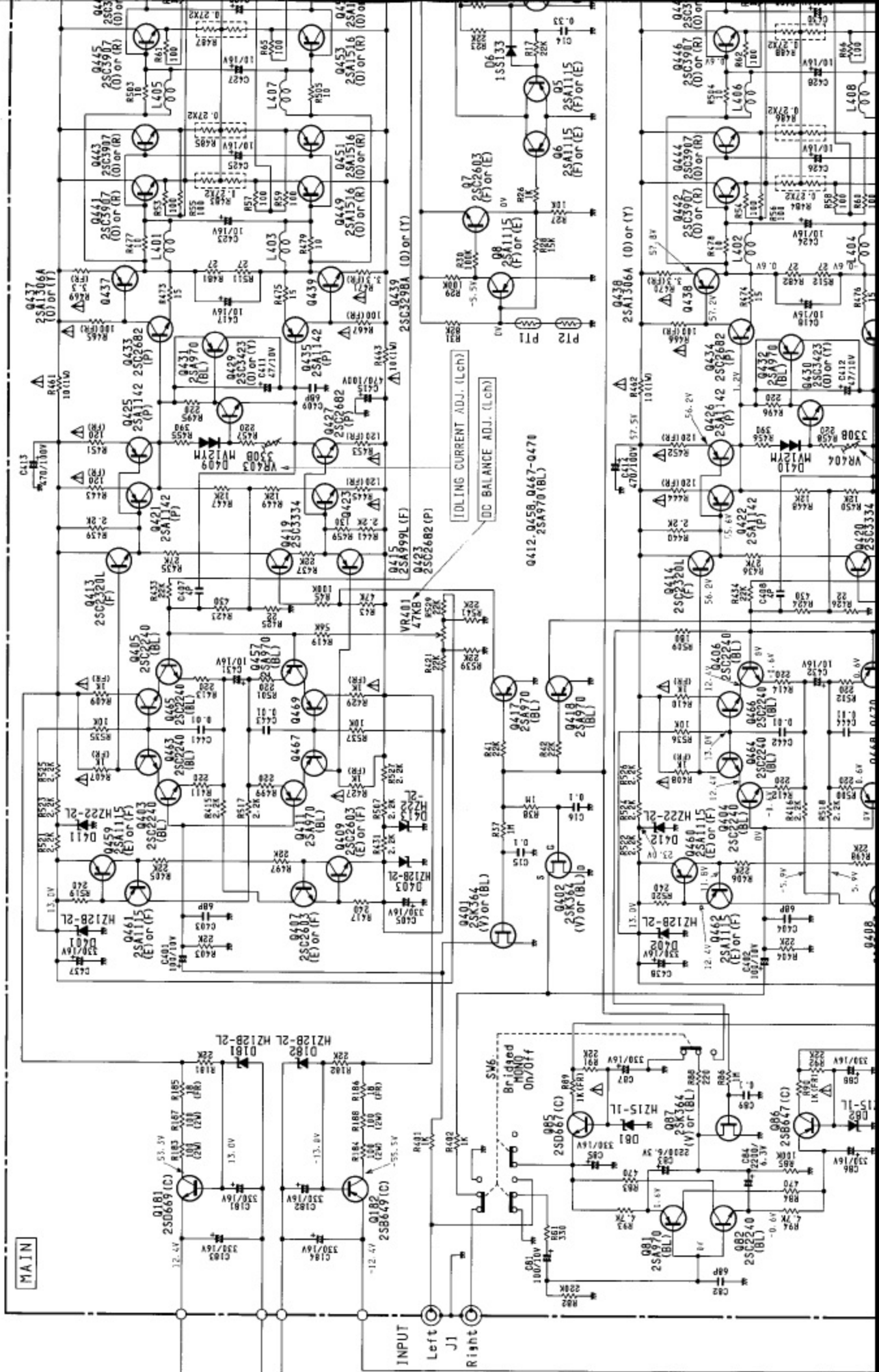

A B C D E F G

1 2 3 4 5

N
M
L
K
J
I
H
G

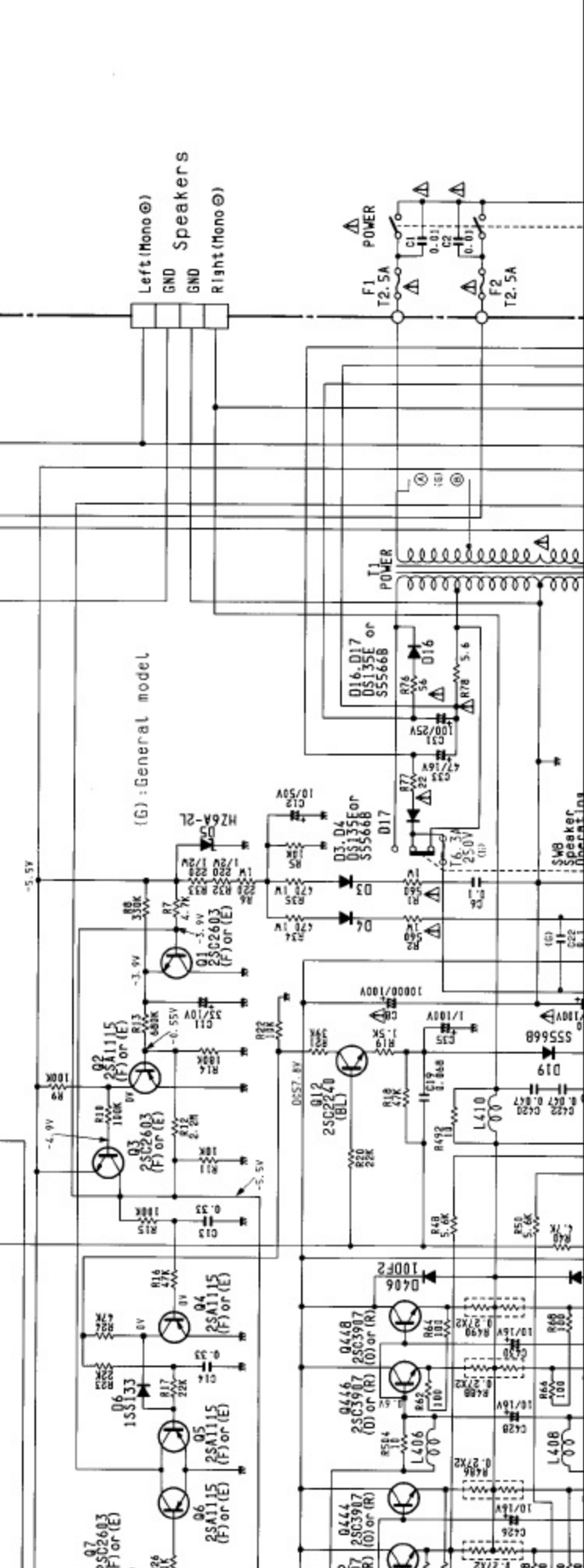
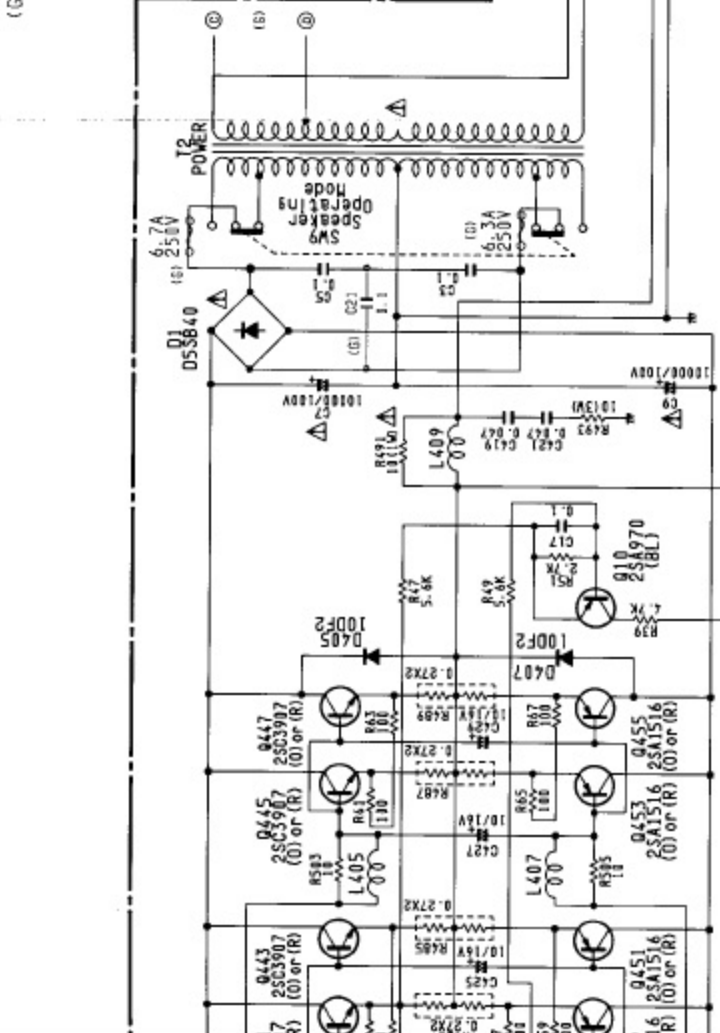
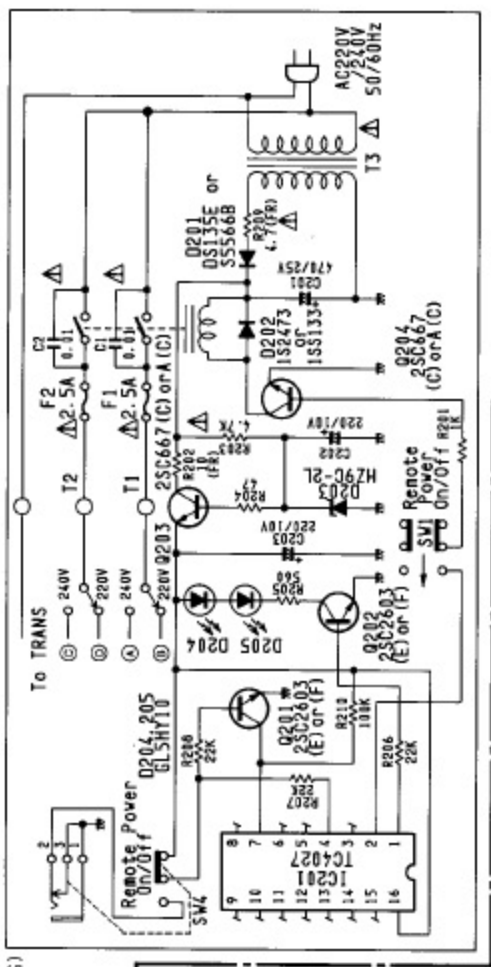

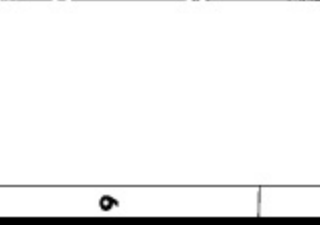
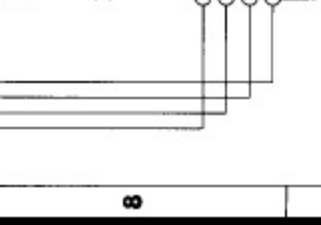
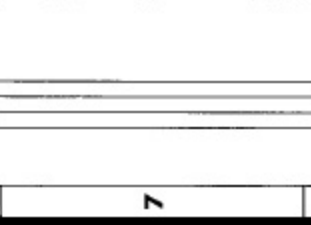
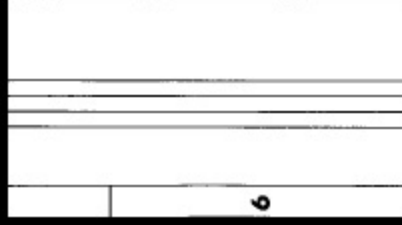
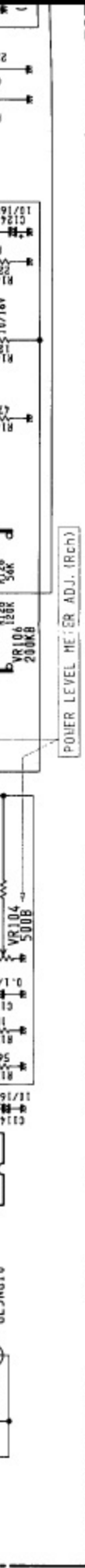
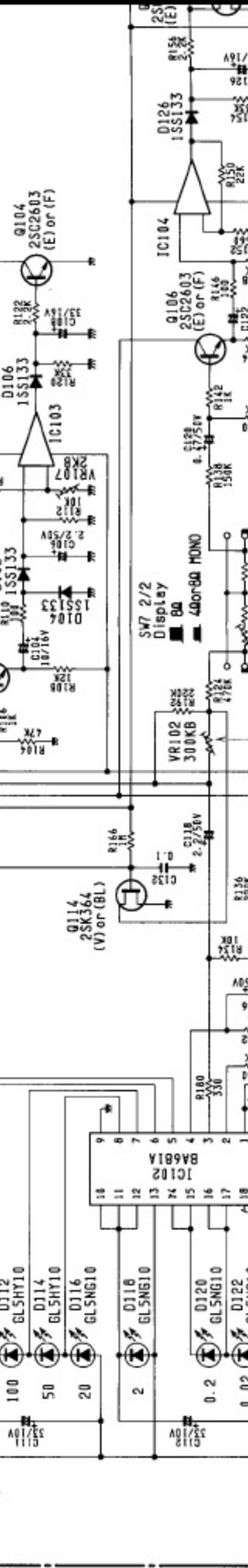
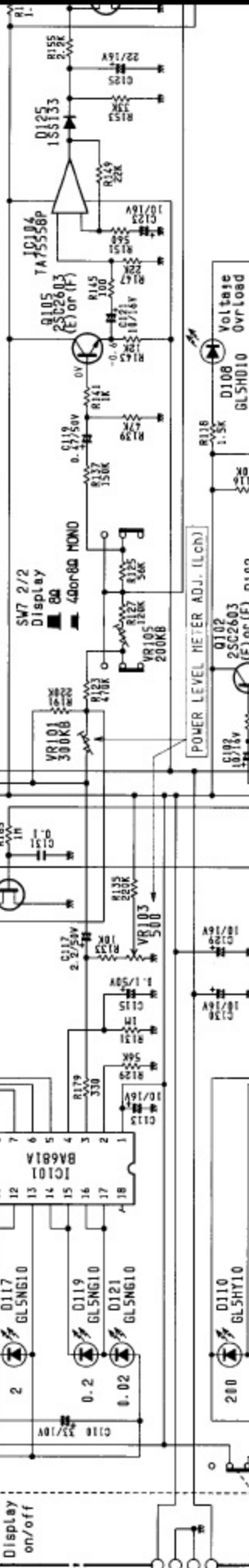
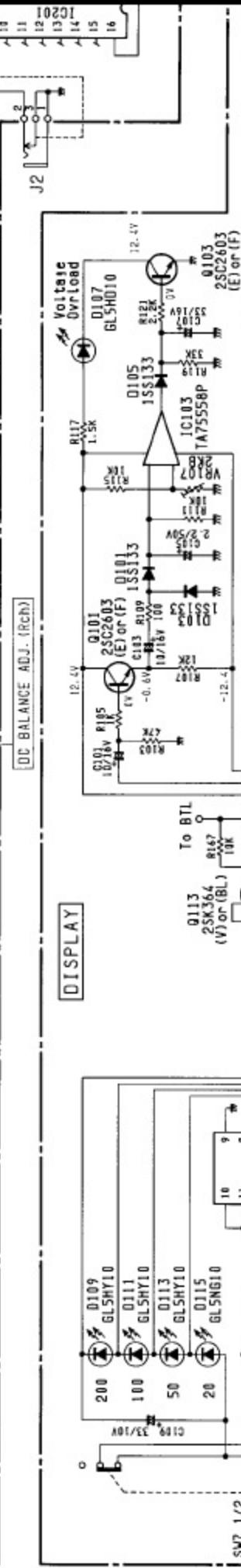
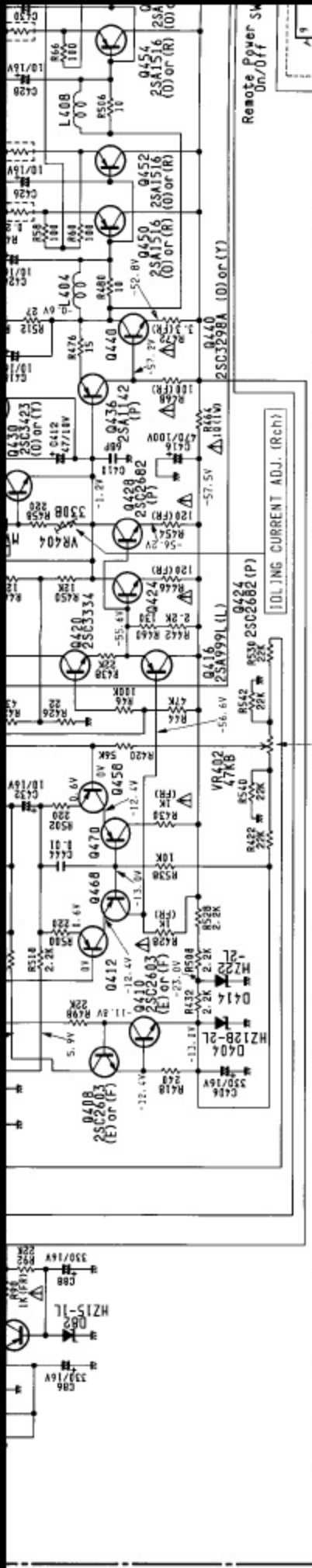

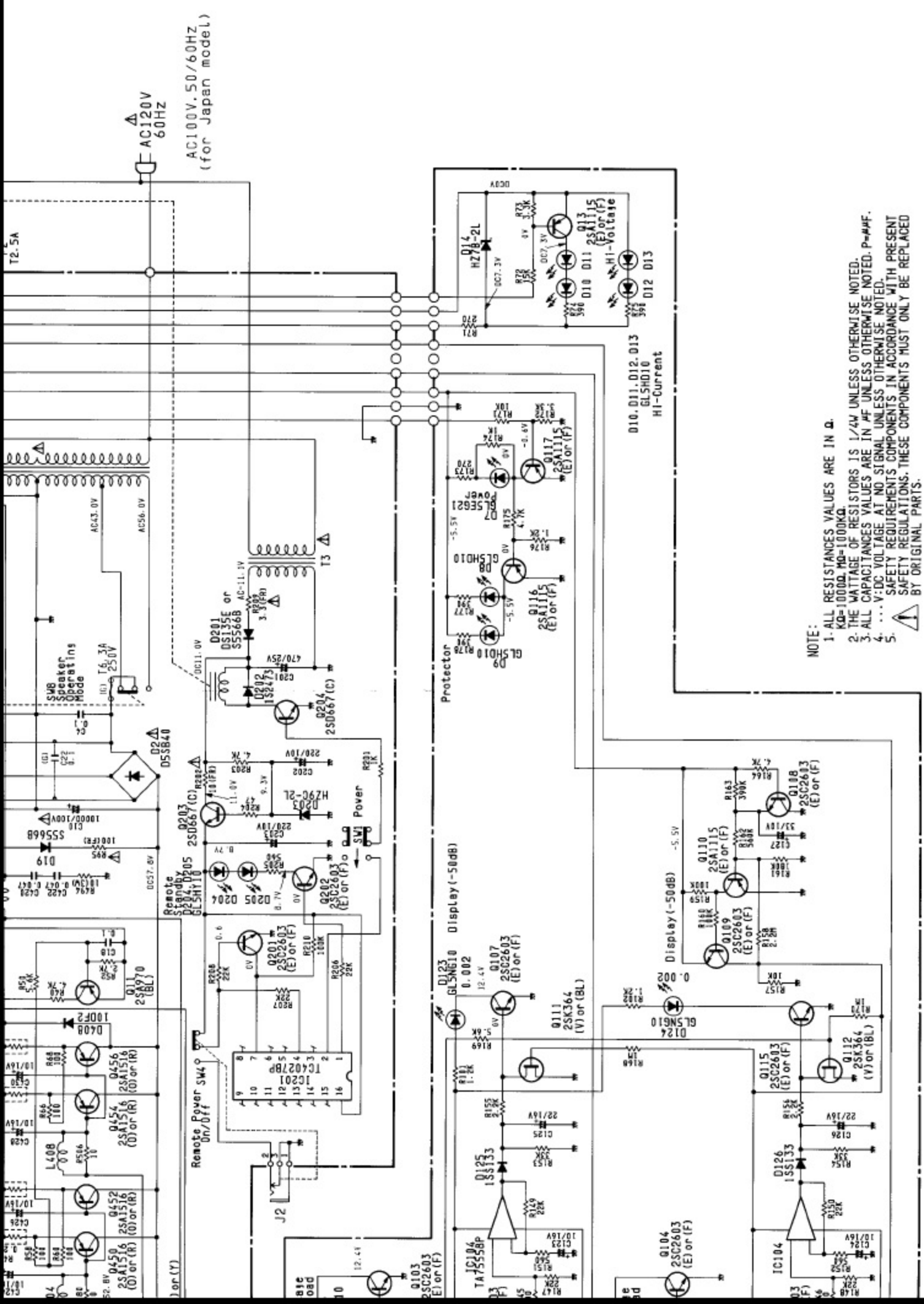

AC120V
60HZ

AC100V, 50/60HZ
(for Japan model)

NOTE:
 1. ALL RESISTANCES VALUES ARE IN Ω .
 2. THE WATTAGE OF RESISTORS IS 1/4W UNLESS OTHERWISE NOTED.
 3. ALL CAPACITANCES VALUES ARE IN μ F UNLESS OTHERWISE NOTED.
 4. ... V: DC VOLTAGE AT NO SIGNAL UNLESS OTHERWISE NOTED.
 5. SAFETY REGULATIONS COMPONENTS IN ACCORDANCE WITH PRESENT SAFETY REGULATIONS. THESE COMPONENTS MUST ONLY BE REPLACED BY ORIGINAL PARTS.